

Data Sheet



Article number: 604144112020

Description: Timing belt pulley with hub
HTD 112 8M 20

Measures

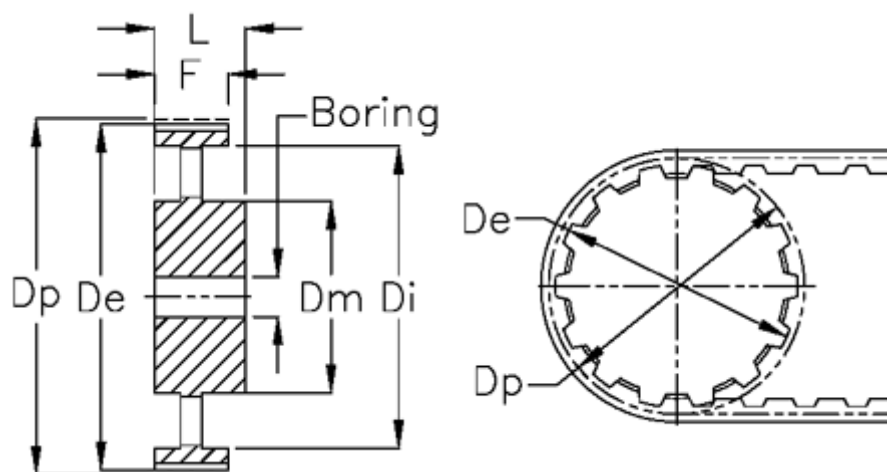

Bore	= 18	Type	= 8M
De	= 283.83	Weight	= 5.2
Di	= 254	Width	= 20
Dm	= 90		
Dp	= 285.21		
F	= 28		
L	= 38		
Tooth number	= 112		